

INSTRUCTION MANUAL

Auto Vacuum System

Model No.

DC Chem 610 Pro



Video List

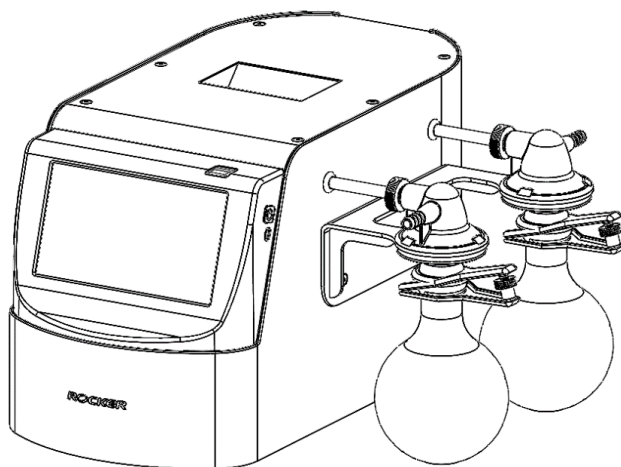

ROCKER

Please read this instruction manual before using this product.

Table of Contents

1. Important Notice	1
2. Unpacking	3
3. Product Description	4
(1) Vacuum Pump	4
(2) Control Panel	5
4. Installation and Connection	5
(1) Vacuum System Installation and Power Supply	5
(2) Installation of Glass Flasks	6
(3) Installation of Control Panel	6
(4) Wireless Connection of Vacuum Pump and Control Panel	7
(5) Tube Connection	7
(6) Example of Use – Rotary Evaporator	7
5. User Interface	8
(1) Main Screen and Operating Elements	8
1.1 Main Screen	8
1.2 Operating Elements, Buttons and Icons	9
(2) Other Screens	11
2.1 Parameter List	11
2.2 Setting	12
2.2.1 Operating	12
2.2.2 Basic	12
2.3 Calibration	13
2.4 Buttons and Icons	13

6. Operation	14
(1) Vacuum Pump	14
(2) Touch Screen	14
(3) Program Operation	15
3.1 Vacuum Control – Pre-defined Program	15
3.2 Add A New Program and Set Parameters	16
3.3 Automatic Mode – Pre-defined Program	17
(4) Adjust Setpoint Pressure	18
4.1 Area for Adjusting Setpoint Pressure	18
4.2 Method for Adjusting Setpoint Pressure	18
(5) Venting	19
(6) Pressure Calibration	19
6.1 Tube Connection	19
6.2 Pressure Sensor Calibration	20
7. Maintenance	21
8. Troubleshooting	21
(1) Error / Warning Message	21
1.1 Error Messages	22
1.2. Error Log	22
1.3 Error Indication	22
(2) Troubleshooting	23

1. Important Notice

This instrument is designed for laboratory usage only. Please read this manual carefully before installing and operating. The instrument shall not be modified in any way. Any modification will void the warranty and may result in potential hazard. We are not responsible for any injury or damage caused by any non-intended purposes and modifying the instrument without authorization.

● Instruction

DC Chem Pro product series is a vacuum system consisting of a BLDC chemical resistant vacuum pump, controller and components (e.g. sensor) for creating and controlling rough vacuum in desired system. The system can be used in several applications, such as evaporation, concentration, vacuum drying, vacuum deposition (PVD, CVD), etc. Please evaluate the applicability and risks before operation, the operator should take full responsibility for any risks arising from the use.

1. Check the voltage specified on the name plate and ensure it matches the line voltage in your location.
2. Install the instrument in a clean, dust-less and ventilated area under 40°C.
3. Never use the vacuum system with any flammable, explosive gas or toxic material.
4. Do not use the vacuum system to pump, deliver and compress solids or fluids.
5. Do not pump any liquid, dust, or any substance which may form deposits in the pump.
6. Please connect the vacuum system with high-pressure hose or tubes.
7. If there is condensate or blockage in vacuum line, it may cause incorrect measurement of pressure sensor (or vacuum sensor).
8. After finishing the experiment, please remove the liquid in the glass flask and keep the pump on. While switch off the panel, the system keeps pumping the air according to the set parameter to withdraw the residual steam.
9. The vacuum system is designed to create vacuum, do not use to create pressure.
10. To ensure a smooth gas emission, please keep the pump outlet clear, unblockage and pressure-free.

11. Venting is introducing air into the evacuated system and can cause danger, e.g. explosive mixture, depending on applications. Be aware of risks during venting.
12. If the instrument is damaged, e.g., supply cord, please contact the manufacturer or your service agent for replacement to avoid hazard.
13. This instrument must be grounded to prevent the risk of electrical short circuit. If there's any doubt about grounding installation, please consult a qualified electrician.
14. After disconnecting the power supply, residual energy at plug might be danger. Please be aware of risks during cleaning and maintenance.
15. No special protective equipment is required during operation. We recommended wearing full protective equipment to avoid danger from residual substances during cleaning, maintenance and repair work.
16. Solvent or hazardous substances could release from pump outlet during operation. We recommended using with suitable cold trap, filters or operating in fume hood.
17. Before operation, please check the compatibility and interactions of materials of pump head, valve plates, diaphragm, etc. with used medium.
18. Please discard packing material according to local related regulations. Please remove batteries before discarding.
19. Operating condition
 - (a) Ambient temperature: 5~ 40°C
 - (b) Relative humidity: 80% RH Max.
 - (c) Power supply: 100-240V~, 50/60Hz, 120W
 - (d) Fuse: T3A, 250V
 - (e) Altitude: up to 2000 m
 - (f) Pollution degree: II
 - (g) Indoor use



Glass is fragile, please take out carefully.



The equipment must be disconnected from the main supply before replacing the fuse.

2. Unpacking

Please check if the package is complete without any damage before unpacking. When unpacking, please make sure you have all accessories that indicated on the list. If there is any problem, please keep the serial number along with packing case and contact your local distributor immediately for assistance.



DC Chem 610 Pro

Model	Standard Package Includes:	
DC Chem 610 Pro	Vacuum Pump (Main Unit)	x 1
	Control Panel	x 1
	Power Cord	x 1
	Spherical Joint Pinch Clamp	x 2
	Lithium-ion Rechargeable Battery, 18650	x 1
	Button Cell Battery, CR1220	x 1
	Repair Kit	x 1
	Instruction Manual	x 1
	500 mL Round Bottom Glass Flask	x 2/pk

3. Product Description

(1). Vacuum Pump



Position	Designation	Position	Designation
1	Main Unit of DC Chem 610 Pro	7	Outlet
2	Charging Pole Piece	8	Spherical Joint Pinch Clamps
3	START / STOP	9	Round Bottom Glass Flask
4	VENT	10	Fan
5	Handle	11	Power Switch
6	Inlet	12	AC Socket and Fuse Holder

(2). Control Panel

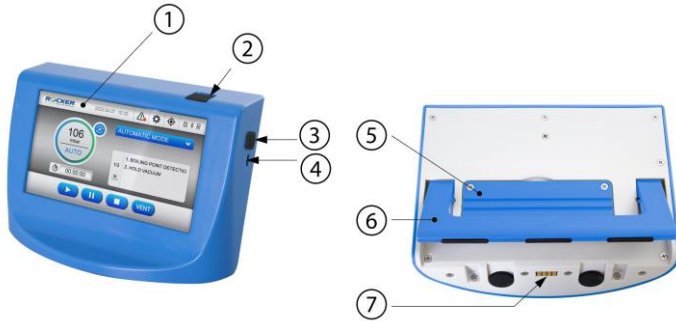

Position	Designation	Position	Designation
1	Touch Screen	5	Battery Cover *
2	Cover of SD Card Slot	6	Stand, foldable
3	ON/OFF Button	7	Charging Pole Piece
4	USB Type-C Charging Port (5V1A)		

* 18650 rechargeable battery is NOT included.

4. Installation and Connection

(1). Vacuum System Installation and Power Supply

The system weights approx. 15 Kg and should be installed on a horizontal, stable platform that has adequate carrying capacity. Please check if the voltage specified on the name plate matches the available line voltage and install the instrument in a clean, dust-less and ventilated area.

- ◆ If there's large temperature difference between storage location and installation location may form condensation and damage the instrument. It's recommended to keep instrument acclimatizing for more than 4 hours before first operation.
- ◆ If installing in the furniture or near other instruments, please keep a minimum distance of 5 cm from adjacent objects and ensure well ventilation.

(2). Installation of Glass Flasks

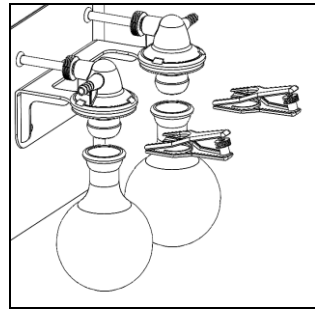
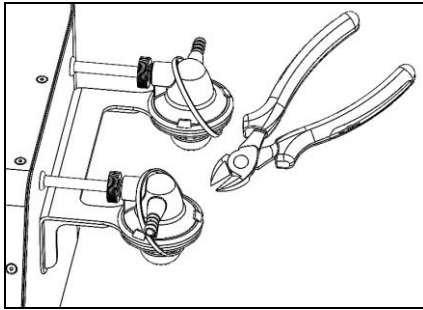

Please cut and remove the fixing cable tie on inlet and outlet. Install 500 mL glass flasks to spherical joint under inlet and outlet, clamp the pinch clamps and screw nut of clamps to fix it.

(3). Installation of Control Panel

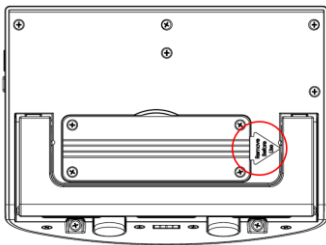

Remove the Insulation Tab

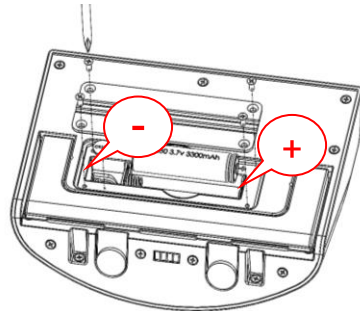

Positive / Negative of Battery



- ◆ If the battery is attached, please remove the battery insulation tab for initial operation.
- ◆ The panel could operate approx. 6 hours while installing an 18650 battery (3350mAh).
- ◆ Please purchase CR 1220 button cell battery when it needs to be replaced.

(A) Loosen the screws of battery cover by Phillips screwdriver and open the battery cover.

(B) Install the 18650 rechargeable battery, please connect electrodes correctly.

(C) Reattach the battery cover on control panel.

(4). Wireless Connection of Vacuum Pump and Control Panel

- (A) Switch on the power switch after correct power source connection.
- (B) Attach or near the control panel to vacuum pump.
- (C) Press and hold the ON/OFF button for 5 seconds to start up the control panel.
- (D) Vacuum pump and control panel connect successfully if a blue Bluetooth icon  shows on the top right of screen.
- (E) If the Bluetooth icon is grey , tap the Setting  icon on the top right of the screen.
- (F) Tap the "START" button of Bluetooth Search in Operating tab to pair the vacuum pump
Repeat the step until Bluetooth connection is successful.
- ◆ Vacuum pump starts pairing with control panel and back to main screen.
- (G) Attach the control panel to power supplied vacuum pump to charge or connect a Type-C cable to USB Type-C charging port of the control panel to charge.

(5). Tube Connection

Please connect the inlet of vacuum system to evacuated instrument with high-pressure hose or tubes

(6). Example of Use – Rotary Evaporator

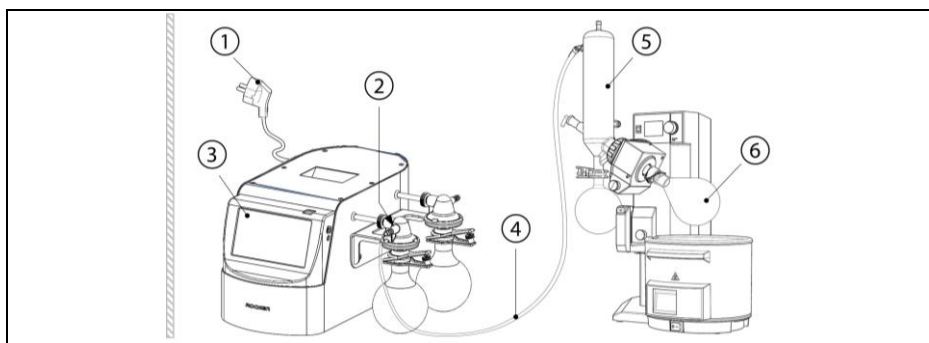

Position	Designation	Position	Designation
1	Power Plug	4	High-pressure Tube
2	Vacuum Pump (Inlet)	5	Example - Emission Condenser
3	Control Panel (Wireless Control)	6	Example – Rotary Evaporator

5. User Interface

(1). Main Screen and Operating Elements

Press and hold the ON/OFF button for 5 seconds to start up the control panel and make sure the vacuum pump and control panel are successfully connected. Instruction of connection, see P.7 [\(4\) Connection of Vacuum Pump and Control Panel](#).

1.1 Main Screen



	Position	Function	Description
Control Zone	1	Start	Start the current program.
	2	Pause	Suspend the ongoing program.
	3	Stop	Stop, abandon the ongoing program.
	4	VENT	Vent the air into evacuated system.
Function Zone	5	Error Log	Warning and error message.
	6	Setting	Basic and operating parameters setting.
	7	Calibration	Calibrate the pressure sensor.
	8	SD Card	SD card inserted or not. (Blue: inserted)
	9	Bluetooth	Bluetooth connection state. (Blue: connection)
	10	Battery Level	Battery level and state. (Blue: charging)







	Position	Function	Description
Operation Zone	11	Program List	Program name, tap to show the program list
	12	Process Display	Overview of process steps, tap to open the Parameter List.
	13	Automatic Mode	Automatic Mode switching on / off.
	14	Pressure Display	Pressure display.
	15	Pressure Sliders	Swipe to adjust the pressure setpoint. Only available while pressure is adjustable.
	16	Process Time	Total process time (hh:mm:ss)

1.2 Operating Elements, Buttons and Icons





• Pressure Display

Position	Symbol	Description
14		<ul style="list-style-type: none"> • Pressure Blue: Setpoint pressure, motor speed (%) Black: Actual pressure * Pressure unit can be changed on Setting page * Blue item changes according to setting item.







• Buttons

Position	Active	Inactive	Description
1			<ul style="list-style-type: none"> • Start Start the current program.
2			<ul style="list-style-type: none"> • Pause Suspend the ongoing program.
3			<ul style="list-style-type: none"> • Stop Stop, abandon the ongoing program.

• Buttons (continued)

Position	Buttons		説明
4		Short Vent	<ul style="list-style-type: none"> • VENT Vent the air into evacuated system. <ul style="list-style-type: none"> ◆ Press button < 3 sec: short vent and program continues. ◆ Hold button > 3 sec.: vent to atmosphere and program suspends.
		Vent to Atmosphere	
13		Automatic Mode	<ul style="list-style-type: none"> • Automatic Mode Switch to Automatic Mode or Other programs.
		Other Programs	

• Icons

Position	Icons		Description
8		SD Card Inserted	<ul style="list-style-type: none"> • SD Card Inserted or not Used for software updates.
		No SD Card	
9		Connection	<ul style="list-style-type: none"> • Bluetooth Connection Check the connection state of vacuum pump and control panel.
		Failed Connection	
10		Charging	<ul style="list-style-type: none"> • Battery Level and Charging Current battery level and charging state. Battery level and state. (Blue: charging)
		Battery Level	

(2). Other Screens

2.1 Parameter List

Display and modify the steps and detailed parameters of the program. Each program is preset with 2 steps, and up to 10 steps can be included in a program.

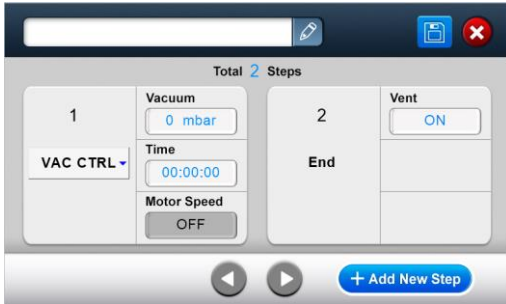

Parameter List

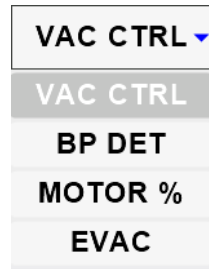

Drop-down Menu - 4 Steps

Steps can be selected from drop-down menu, the steps include

- **Vacuum Control (VAC CTRL):** maintains a setpoint pressure for a set period.
- **Evacuate (EVAC):** evacuate to setpoint pressure at a set motor speed (%).
- **Motor Speed (MOTOR %):** operate a set motor speed (%) for a set period.
- **Boiling Pressure Detection (BP DET):** same as Automatic Mode, enable detection boiling point (bp) pressure automatically and maintain the bp pressure for a set period.
Detection sensitivity is adjustable.

- ◆ Item with underline is the set parameters of the step.
- ◆ If time is set as 00:00:00 (hh:mm:ss), it stands for infinite process.

2.2 Setting

Tap the setting button  on the main screen to enter the setting page. Setting page is divided into Operating and Basic by tabs

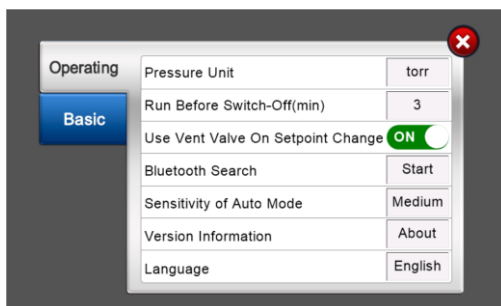

2.2.1 Operating Setting

- **Pressure Unit:** mbar, hPa, torr.
- **Run Before Switch-Off (min):** a self-clean mechanism, the pump and valves open for a set period after switching off the control panel. To remove the solvent residues and increase the service life of pump, please do NOT switch off the pump until cleaning is complete.
- **Use Vent Valve on Setpoint Change:** whether the system use the vent valve to adjust the pressure during operation. This setting is NOT applied to manual VENT on the main screen.
- **Bluetooth Search:** Bluetooth connection, see P.7 (4) Wireless Connection of Vacuum Pump and Control Panel.
- **Sensitivity of Auto Mode:** adjust the sensitivity of Automatic Mode .
- **Version Information**
- **Language:** English, Chinese.

2.2.2 Basic Setting







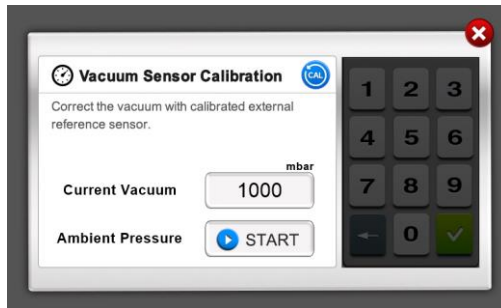





- **Display Brightness:** 20% / 40% / 60% / 80% / 100%.
- **Energy Saving Mode:** the screen will dim after 1 minute of standby, tap to wake it.
- **Button Tone:** ON / OFF.
- **Error Tone:** ON / OFF.
- **Date:** YYYY / MM / DD.
- **Time:** hh:mm:ss, 24-hour clock.
- **Factory Default Setting**

2.3 Calibration

Tap the calibration button  on the main screen to calibrate the pressure sensor.



2.4 Buttons and Icons



Buttons	Description
	• Cancel entry and modifications. Exit the window and back to previous page.
	• Confirm entry and modifications. Save setting and back to previous page.
	• Delete the entry number or letter(s).
	• Save the modified parameters.
	• Save as a new program.
	• Delete the step or program.
	• Switch ON and OFF the set parameters.
	• Switch between the previous / next pages.
	• Reset the pressure sensor to factory defaults.
	• Execute the pressure sensor calibration.
	• Modify the program name.
	• Add a new step.

6. Operation

(1). Vacuum Pump



The complete functions of the system should be operated through control panel. Basic operation, such as start, stop and vent, could be done through the button on vacuum pump.

- ◆ Max. vacuum of the system is related to air leakage of the evacuated system, a slight drop of 3~5 mbar is possible. If there's a serious pressure drop, please contact your local distributor or us for help.
- ◆ If the system is operated with substance that are aggressive, allergic, or might cause dangerous reaction, it should be placed in a fume hood.

Buttons	Function	Description
	Power Switch	Located on the back of vacuum pump, Used to switch on and off the power of pump
	START / STOP	Located on the front plate of vacuum pump. Used to start and stop the vacuum pump.
	VENT	Located on the front plate of vacuum pump. Used to vent the air into evacuated system.

(2). Touch Screen

The system is operated via touch screen. You can select and activated the function by tapping operation elements, buttons, etc.

Symbols	Gesture	Applied to
	Tap	Most buttons, such as start, stop, pause, process display, Automatic Mode, etc.
	Press and hold	VENT
	Swipe up and down	Pressure Sliders



(3) Program Operation

DC Chem Pro vacuum system has built in pre-defined program or can add a new program according to applications. Please ensure the tube connection and wireless connection are ready, see P.7 (4) Wireless Connection of Vacuum Pump and Control Panel and (5) Tube Connection.

- (Pre-defined) 3.1 Vacuum Control: See P.15.
- (Self-built) 3.2 Add A New Program: See P.16.
- (Pre-defined) 3.3 Automatic Mode: See P.17.

3.1 Vacuum Control – Pre-defined Program

Maintain a setpoint pressure until stop the program.

- (A) Select the “Vacuum Control” from program list.
- (B) Tap “Pressure Display Element” to input the setpoint pressure; or roughly regulate by swiping the pressure sliders.
- ♦ See P.18 (4) Adjust Setpoint Pressure.
- (C) Tap  to start the vacuum control program.
- ♦ The setpoint pressure is adjustable during operation.
- (D) Tap  or  to pause or stop the vacuum control program.



3.1.(A) Program List – Vacuum Control

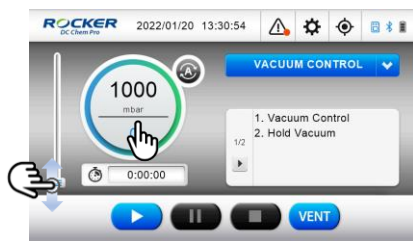

3.1.(B) Adjust Setpoint Pressure



3.1.(C) Start Vacuum Control

3.2 Add A New Program and Set Parameters

Build customized program according to application, each program can have up to 10 steps.

(A) Select the “Add A New Program” from program list.

- ◆ Program list shows name of current program, tap to select programs or build a new one.

(B) Set the “step” and “target parameters” in screen of Parameter List.

- ◆ Step is selected from drop-down menu. The 4 built-in steps and definition, please see P.11 (2).2.1 Parameter List.
- ◆ See P.18 (4) Adjust Setpoint Pressure.



(C) Tap  to add a new step between existing 2 steps.

- ◆ Tap  to delete the step.
- ◆ The “End” step is used to determine the state of program end.
 - Vent ON: vent to atmosphere; Vent OFF: Keep the system closed with existing pressure.

(D) Tap  to save the new-built program and input the program name.

- ◆ Tap  to edit and modify the program name.

(E) Tap  to start the self-built program.

(F) Tap  or  to pause or stop the self-built program.

(G) Tap the “Process Display” to view or modify the parameters of saved program.

- ◆ The number on the left of process display stands for current step / total number of step.
 - Tap arrow to skip and enter to next step.



3.2.(A) Program List – Add A New Program

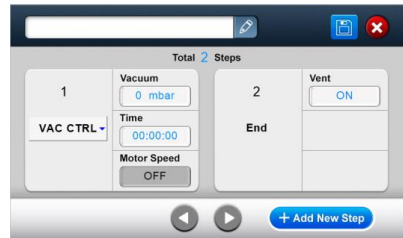

3.2.(B) Parameter List – Step and Parameters

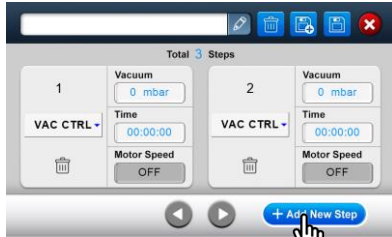

3.2.(C) Parameter List – Add New Step

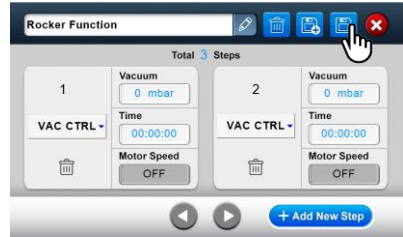

3.2.(D) Save The Program



3.2.(E) Start Self-built Program

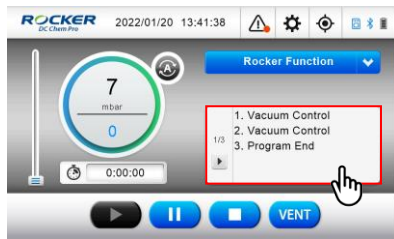

3.2.(G) Parameters Modification

3.3 Automatic Mode – Pre-defined Program



When evaporation and distillation of unknown solvents, the boiling point pressure can be automatically detected by selecting the Automatic Mode.

- ◆ Sensitivity of Automatic Mode can be adjusted in Setting pages, see P.12 Operating Setting.

(A) Select the  Automatic Mode in Main Screen. You are in Automatic Mode if the  is blue and Program List shows Automatic Mode.

- ◆ The only way to exit the Automatic Mode is to tap the blue  and turns it into grey , then you can select the other programs from Program List.

(B) Tap  to start the Automatic Mode. While boiling point pressure is detected, the AUTO shows pressure simultaneously and hold the pressure throughout the process.

(C) Tap  or  to pause or stop the Automatic Mode. The pressure is vented to atmospheric pressure while end of the Automatic Mode.

(D) Tap  to exit the Automatic Mode, then other programs can be selected.



3.3.(A) Automatic Mode



3.3.(B) Boiling Point Pressure Detection



3.3.(C) Stop Automatic Program



3.3.(D) Exit Automatic Mode

(4). Adjust Setpoint Pressure

DC Chem Pro vacuum system offers various options for adjusting the setpoint pressure which is adjustable during operation.

- ◆ The setpoint pressure cannot be adjusted from the main screen if pressure is not the setting parameter. Please adjust the setpoint or parameters by taping Process Display.

4.1 Area for Adjusting Setpoint Pressure



Main Screen – Pressure Display or Sliders

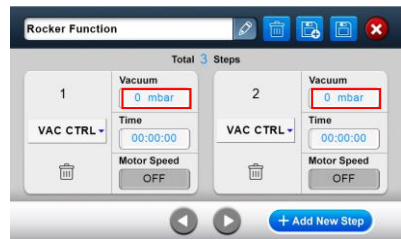

Parameter List – Vacuum Box

4.2 Method for Adjusting Setpoint Pressure



Keypad



Pressure Sliders

(5). Venting

DC Chem Pro vacuum system can vent the air into the evacuated system manually to regulate the pressure or prevent the bumping.

- ♦ Venting is introducing air into the evacuated system and can cause danger depending on applications, e.g. explosive mixture. Be aware of risks during venting.



Briefly Press Button for < 3 Second
Short vent and program continues.

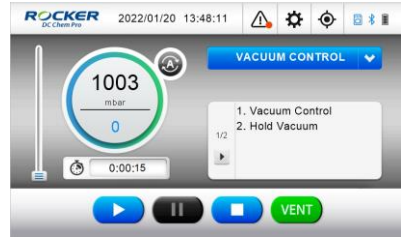

Hold Button for > 3 Second, VENT is Green
Vent to atmosphere and program suspends.

(6). Pressure Calibration

Calibration is to correct the internal pressure sensor by an external reference sensor, please calibrate system with a calibrated reference sensor to ensure the accuracy.

- ♦ If there is condensate or blockage in vacuum line, it may cause incorrect measurement of pressure sensor (or vacuum sensor).

6.1 Tube Connection

Please connect the absolute pressure gauge to the inlet of vacuum pump.



6.2 Pressure Sensor Calibration

(A) Tap the  Calibration Button on the upper right of the main screen to enter the calibration page.

- ◆ Current Vacuum shows the present pressure of the pressure sensor.

(B) Tap  to release pressure automatically and detect current pressure .

(C) After detection, please input the reading of absolute pressure. Tap Confirm  to complete the ambient pressure calibration and followed by second point calibration.

(D) The 2nd point - High Pressure calibration starts and continues until pressure is stable.

(E) After detection, please input the reading of absolute pressure. Tap confirm  to complete the calibration process.

- ◆ After calibration is complete, it returns to main screen and vents to atmosphere.

(F) Tap  to reset the pressure sensor to factory defaults if necessary.



6.2.(A) Main Screen - Calibration

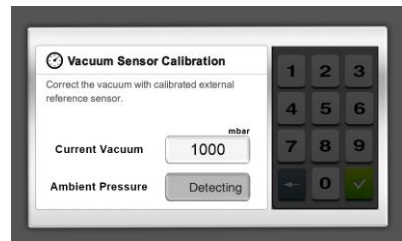

6.2.(B) Ambient Pressure Calibration

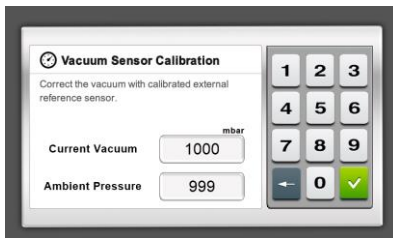

6.2.(C) Input Reading and Confirm

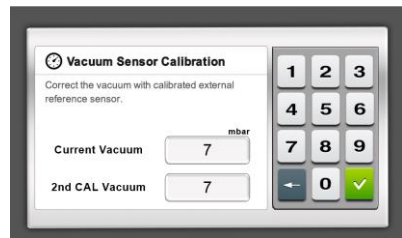

6.2.(E) High Pressure Calibration

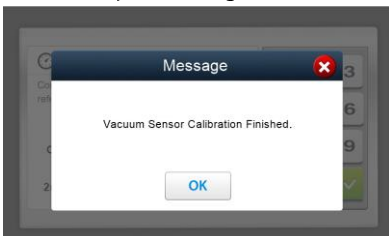

6.2.(E) Calibration Complete

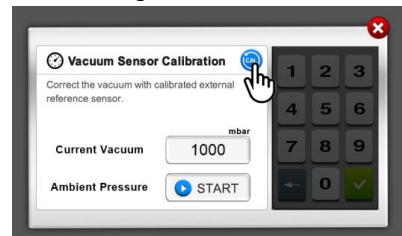

6.2.(F) Reset Calibration to Factory Defaults

7. Maintenance

1. Please operate the instrument in a well-ventilated area and keep it clean.
 2. The instrument is not autoclavable. Please clean the surface by pure water or 75% ethanol.
 3. If there's any solution drop or splash to instrument, please switch off and unplug it immediately and clean the surface to prevent damage from penetration or corrosion.
 4. Please discard the residues in flask after every use. Chemical residues should be removed following general rules for working with chemicals.
 5. After finishing the experiment, please turn on the Self-Clean Mechanism (see P.12 (2).2.1 Operating Setting) and keep the pump on. While switch off the panel, the system keeps pumping the air according to the set parameter to withdraw the residual steam and prolong the life of instrument.
 6. If fuse blows, please troubleshoot and solve problems first. When replace fuse, get the spare fuse from the fuse holder by a flathead screwdriver.
 7. Valve plate(s), O-ring(s), tubing, diaphragm, etc. are consumables, it is recommended to replace it on a yearly basis or as needed to ensure good operation.
- ◆ *If machine is forced to switch on when liquid flow in, it might cause serious damage, such as electric shock, short circuit, burn out, etc.*

8. Troubleshooting

(1). Error / Warning Message

If error happens during operation, a pop-up window appears to indicate. The instrument will be paused or stopped depends on severity. The error indicates by its color and symbol:

Serious



Minor



1.1 Error Messages



A. Error Message

Error Log			
Date	Time	Code	Message
2023/01/20	13:48:41	e03	Bluetooth disconnect !
2023/01/20	13:30:14	e03	Bluetooth disconnect !

B. Error Log

(1) Type of Symbol ;(2) Error Code and Message

1.2. Error Log

Error messages can be checked by tapping  Error Log page on the main screen.

Red dot  stands for new messages.

1.3 Error Indication

Error Code & Description	Reason	Solution
e01 Pump or Driver Fault!	1. Loose or faulty driver cable.	Reconnect or replace driver cable.
	2. Loose or faulty driver signal wires.	Reconnect or replace driver signal wires.
	3. Crashed driver.	Disconnect the power, then re-plug and switch on again.
	4. Faulty driver.	Replace a new driver.
	5. Faulty vacuum pump.	Replace a new vacuum pump.
e03 Bluetooth Disconnect!	1. Inactive vacuum pump.	Plug and switch on the pump.
	2. Exceeded distance of control panel and pump.	Shorten distance of panel and pump.
	3. Faulty Bluetooth module of control panel.	Replace a new board of control panel.
	4. Faulty Bluetooth module of main board.	Replace a new main board.
e04 Vacuum Sensor Fault!	1. Loose or faulty connector of vacuum sensor.	Re-plug or replace the connector.
	2. Defective vacuum sensor.	Replace a new vacuum sensor.
e06 Battery Sensor Fault!	1. Faulty PCB parts of control panel.	Replace a new PCB of control panel.

Error Code & Description	Reason	Solution
e07 Vent Valve Fault	1. Faulty venting valve.	Replace a new venting valve.
	2. Loose or faulty connecting wires of venting valve.	Reconnect or replace connecting wires of venting valve.

(2). Troubleshooting

Problem	Reason	Solution
Vacuum Pump - Fail to start	1. Loose plug.	Reconnect plug to socket firmly.
	2. Faulty power switch.	Replace a new power switch.
	3. Blown fuse.	Replace a new fuse.
	4. Faulty main board or display board.	Replace new main board or display board.
	5. Faulty power supply.	Replace a new power supply.
Control Panel - Abnormal display or Fail to start	1. No battery.	Install the specified battery.
	2. Dead battery.	Attach the panel to pump or connect a Type-C cable to charge.
	3. Faulty main board.	Replace a new main board.
Abnormal operation of touch screen	1. Incorrect, damaged, loose wirings.	Replace new wirings and connect it correctly.
	2. Faulty display.	Replace a new display.
	3. Faulty main board.	Replace a new main board.
No or low acoustic sound	1. Button Tone is OFF.	Set the Button Tone ON.
	2. Sticker is on buzzer.	Remove the sticker on the buzzer.
	3. Faulty main board.	Replace a new main board.
Poor vacuum	1. Improperly pressure setting.	Reset the pressure properly.
	2. Leaking tubing.	Reinforce the leaking tubing.
	3. Faulty vacuum pump.	See P.23 - Vacuum Pump Fail to start.
	4. Faulty vacuum sensor.	Replace a new vacuum sensor.
	5. Faulty venting valve.	Replace a new venting valve.
	6. Faulty main board.	Replace a new main board.

(2). Troubleshooting (continued)

Problem	Reason	Solution
Disconnected panel or parameters is not updated instantly	1. Faulty or crashed communication modules.	Reinstall the 18650 battery correctly.
	2. Incorrect programming version.	Programming the correct version.

- ◆ Above is the basic instruction of troubleshooting. For technical support, please contact your local distributor or Rocker for assistance.

9. Ordering Information

182610-01(02)-P	DC Chem 610 Pro, Auto Vacuum System, AC100-240V, 50/60Hz, US plug (EU plug)
182610-50	Glass Flask Set for DC Chem 610 Pro, includes 500 mL Flask x 2
182610-51-P	Emission Condenser for DC Chem 610 Pro
182610-62-P	DC Chem 610 Pro Repair Kit
180300-68	Silicone Tube, $\varnothing 8 \times 14$ mm, 2 m

Rocker Scientific Co., Ltd.

Tel: +886-2-26033311 Fax: +886-2-26036622

E-mail: export@rocker.com.tw <https://www.rocker.com.tw>